

WORLD MARKET®

Assembly Instructions

BUNDLE - SEGOVIA METAL 3 PC
OUTDOOR FURNITURE SET W/ CHAIRS

SKU 958

1x METAL SEGOVIA SOFA
2x METAL SEGOVIA CHAIR

See following pages for individual
component assembly instructions

WORLD MARKET®

Assembly Instructions

METAL SEGOVIA SOFA

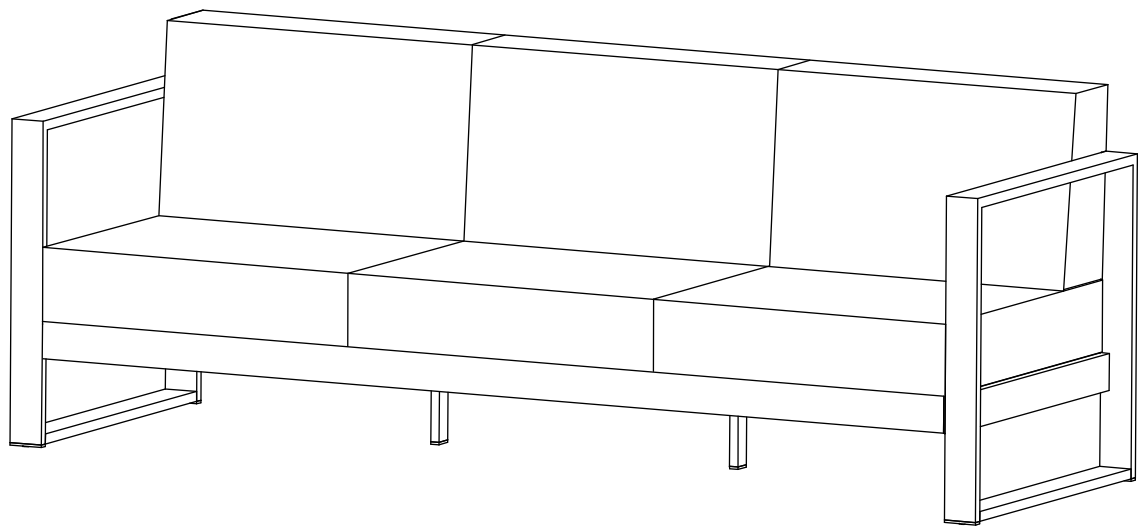

SKU - 619691







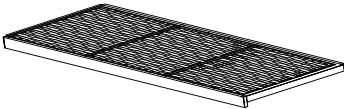
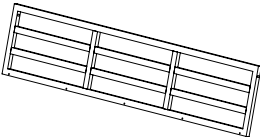
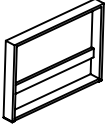
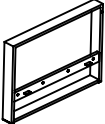

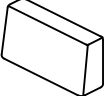
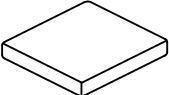
Thank you for your purchase. If you have any questions pertaining to the assembly of this furniture piece, please contact the nearest World Market store. If you are not near a store, please call our customer service call center toll free at 877-967-5362 for assistance.

ALL PRODUCTS SOLD AT WORLD MARKET ARE NOT
FOR COMMERCIAL USE AND ARE INTENDED FOR
RESIDENTIAL USE ONLY.

Component List

LABEL	PICTURE	DESCRIPTION	QTY
A		Seat Frame	1
B		Back Frame	1
C		Right Leg	1
D		Left Leg	1
E		Center Leg	2
F		Back Cushion	3
G		Seat Cushion	3

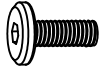
Hardware List

LABEL	PICTURE	DESCRIPTION	QTY
H-1		Long Allen Bolt (M6x55)mm	2
H-2		Short Allen Bolt (M6x40)mm	13
H-3		Spring Washer M6	15
H-4		Flat Washer (M6x1)mm	15
H-5		Shorter Allen Bolt (M8x20)mm	4
H-6		Spring Washer M8	4
H-7		Flat Washer (M8x1.2)mm	4

Tool List

LABEL	PICTURE	DESCRIPTION	QTY
T-1		Allen Key	2

Assembly Preparation

Before Beginning:

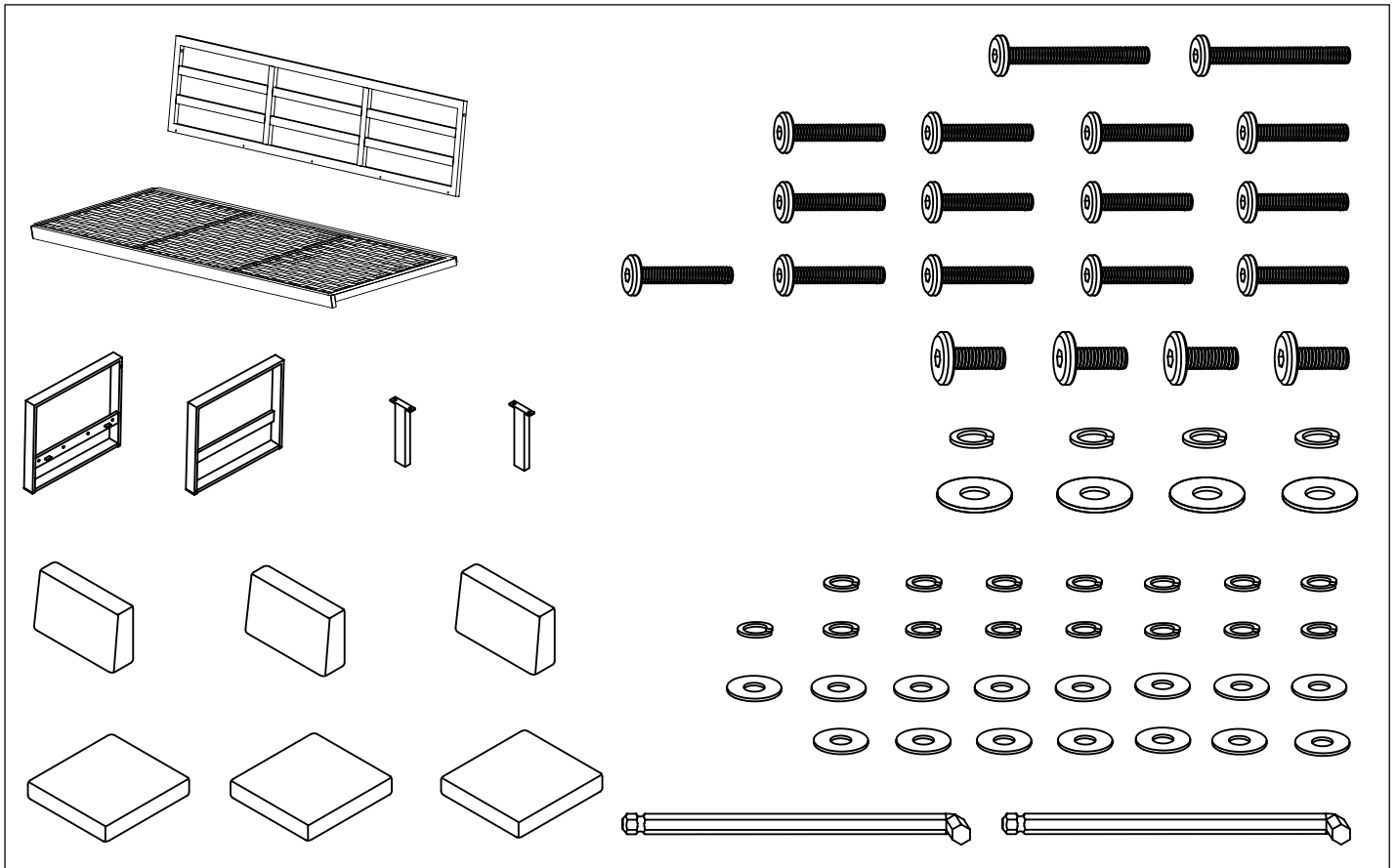

Unpack all hardware bags and components to ensure you have all parts. Take note of bolt hardware size differences and components that may have directional labels (Example: TOP or FRONT).



Read the assembly instructions, cover-to-cover. Save any **Care and Maintenance** instructions pages for after the assembly has been completed.



It is always recommended to have 2 adults on hand for assembly.



Do not assemble on hard, abrasive flooring or carpeted surfaces that can damage or get caught in the components during assembly.

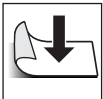

Assemble on a clean non-marring surface (such as the product's packing foam).



Do not discard any packaging until the product has been fully assembled.







In case of missing parts, please contact your nearest World Market store or call our customer service call center at 1-877-967-5362



WARNING: Small parts are a choking hazard. Adult supervision is required before, during, and after assembly.

Assembly



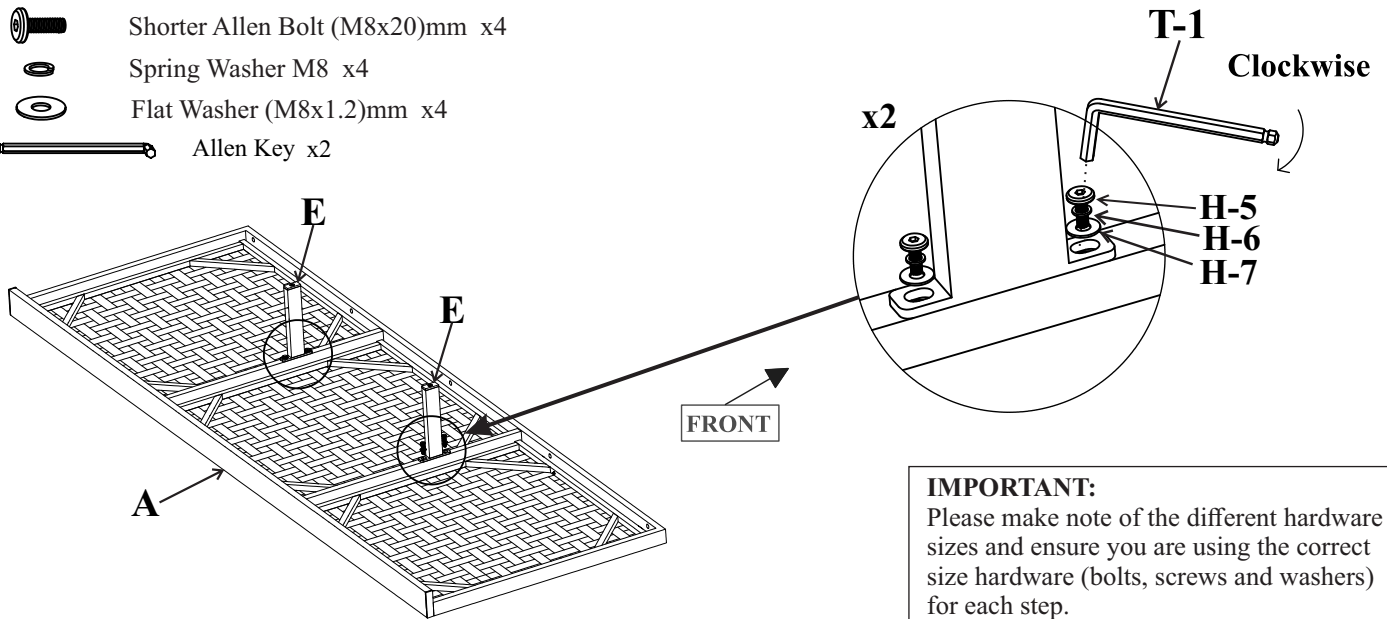

Step 1

- H-5  Shorter Allen Bolt (M8x20)mm x4
- H-6  Spring Washer M8 x4
- H-7  Flat Washer (M8x1.2)mm x4
- T-1  Allen Key x2



Using a second person to assist you, Place Seat Frame (A) upside down onto a padded, non-marring surface. Position the Center Legs (E) onto the crossbars as shown. Secure both Center Legs (E) to the **Seat Frame (A)** with **Shorter Allen Bolts (H-5)**, **Spring Washers (H-6)** and **Flat Washers (H-7)** using the provided **Allen Key (T-1)**, stacking the hardware in the order as shown. Engage all bolts first, then fully tighten. **DO NOT OVER TIGHTEN.**

Step 2



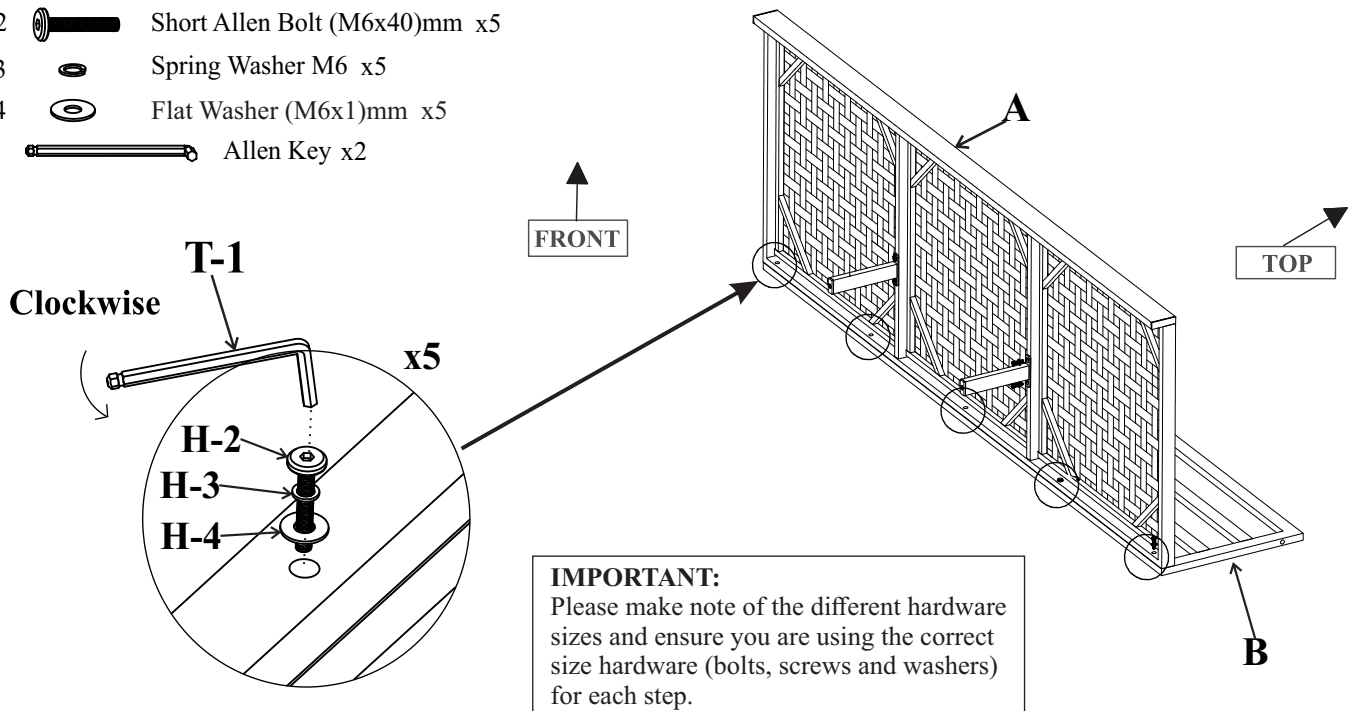

- H-2  Short Allen Bolt (M6x40)mm x5
- H-3  Spring Washer M6 x5
- H-4  Flat Washer (M6x1)mm x5
- T-1  Allen Key x2



Using a second person to assist you, position the Seat Frame (A) with the Back Frame (B) as shown. While one person holds the Seat Frame (A), secure with **Short Allen Bolts (H-2)**, **Spring Washers (H-3)** and **Flat Washers (H-4)** using the provided **Allen Key (T-1)**, stacking the hardware in the order as shown. Engage all bolts first, then fully tighten. **DO NOT OVER TIGHTEN.**

Assembly

Step 3

- H-1  Long Allen Bolt (M6x55)mm x2
- H-2  Short Allen Bolt (M6x40)mm x8
- H-3  Spring Washer M6 x10
- H-4  Flat Washer (M6x1) x10
- T-1  Allen Key x2

IMPORTANT:

Please make note of the different hardware sizes and ensure you are using the correct size hardware (bolts, screws and washers) for each step.

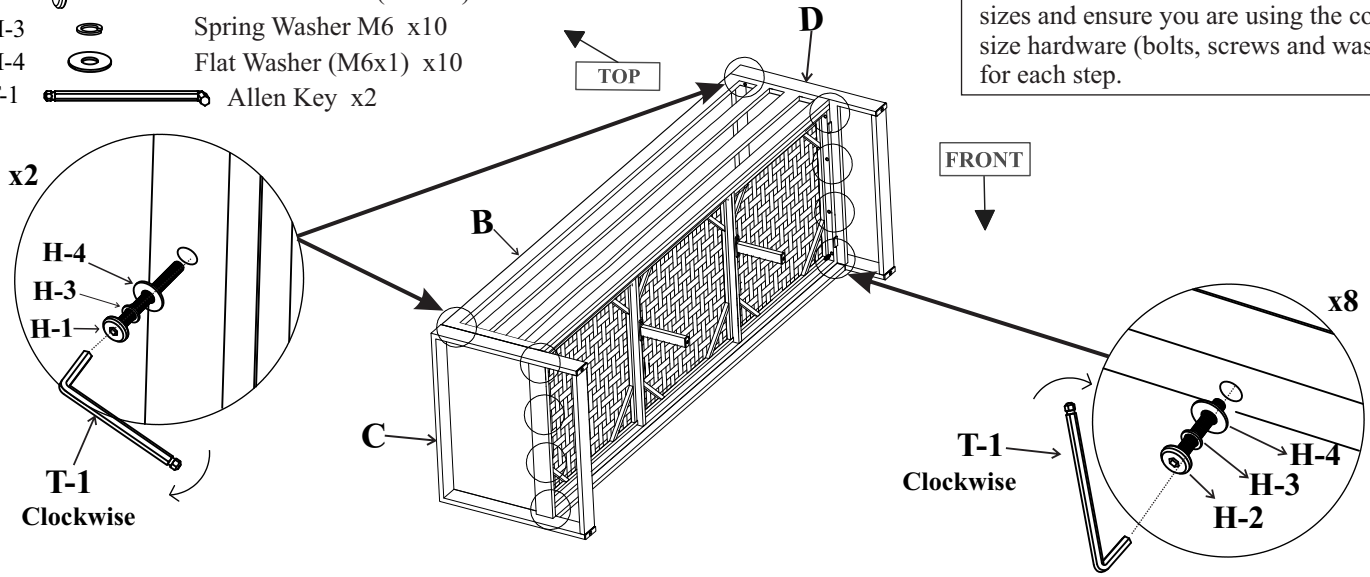

Position the Right Leg (C) with the assembly as shown. Note that the Left/Right Leg (C/D) assemblies have preattached tabs that help align the components. Secure the Right Leg (C) to the **Back Frame (B)** with **Short Allen Bolts (H-2)**, Spring Washers (H-3) and Flat Washers (H-4) using the provided Allen Key (T-1), stacking the hardware in the order as shown. Do not yet fully tighten. Secure the Right Leg (C) to the **Seat Frame (A)** with **Long Allen Bolts (H-1)**, Spring Washers (H-3) and Flat Washers (H-4) using the provided Allen Key (T-1), stacking the hardware in the order as shown. Do not yet fully tighten. Repeat the same process for the Left Leg (D). Once all hardware is engaged, fully tighten. **DO NOT OVER TIGHTEN.**

Step 4

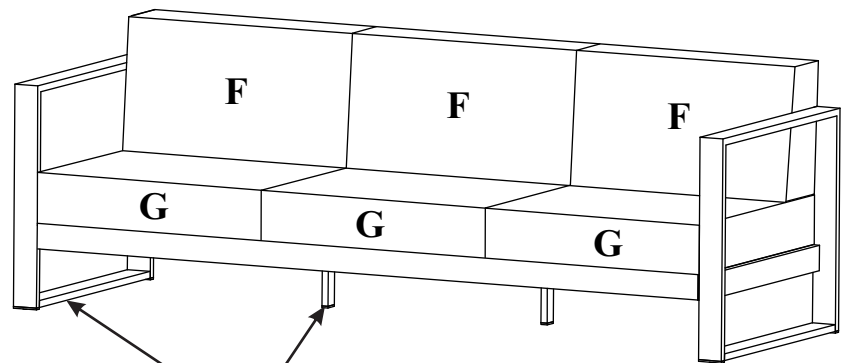
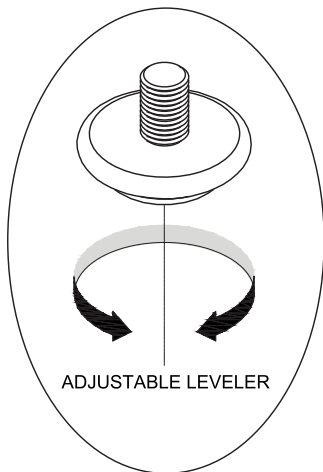

Levelers are located on the bottom of each leg and may be used for additional adjustment if needed for uneven surfaces.

Using a second person to assist you, turn the assembly upright. Place Seat Cushions (G) and Back Cushions (F) into position as shown above. Ensure the zippers face down.

Assembly is now complete and the product is ready for use. Adjustable levelers are located on the bottom of each leg and may be adjusted by turning outwards, counter-clockwise to help account for uneven surfaces.

NOTE: Hardware may loosen over time. Periodically check that all connections remain tight and adjust as needed.

WORLD MARKET®

Assembly Instructions

METAL SEGOVIA CHAIR

SKU - 619721

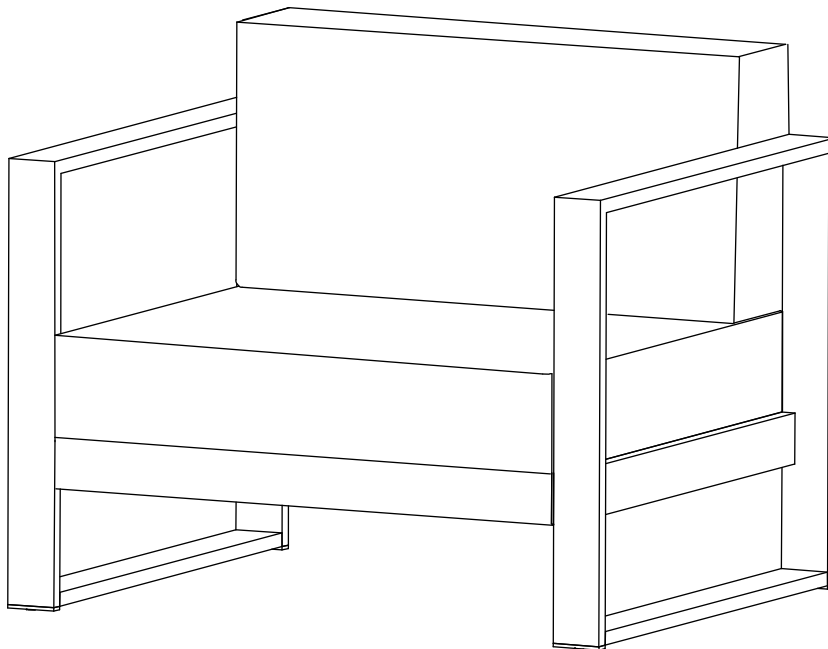



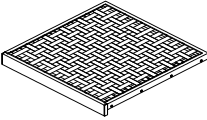
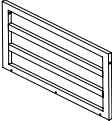
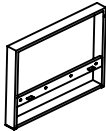
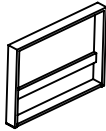
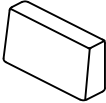
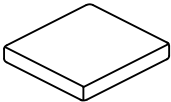

Thank you for your purchase. If you have any questions pertaining to the assembly of this furniture piece, please contact the nearest World Market store. If you are not near a store, please call our customer service call center toll free at 877-967-5362 for assistance.

ALL PRODUCTS SOLD AT WORLD MARKET ARE NOT
FOR COMMERCIAL USE AND ARE INTENDED FOR
RESIDENTIAL USE ONLY.

Component List

LABEL	PICTURE	DESCRIPTION	QTY
A		Seat Frame	1
B		Back Frame	1
C		Right Leg	1
D		Left Leg	1
E		Back Cushion	1
F		Seat Cushion	1

Hardware List

LABEL	PICTURE	DESCRIPTION	QTY
H-1		Long Allen Bolt (M6x55)mm	2
H-2		Short Allen Bolt (M6x40)mm	11
H-3		Spring Washer M6	13
H-4		Flat Washer (M6x1)mm	13

Tool List

LABEL	PICTURE	DESCRIPTION	QTY
T-1		Allen Key	2

Assembly Preparation

Before Beginning:

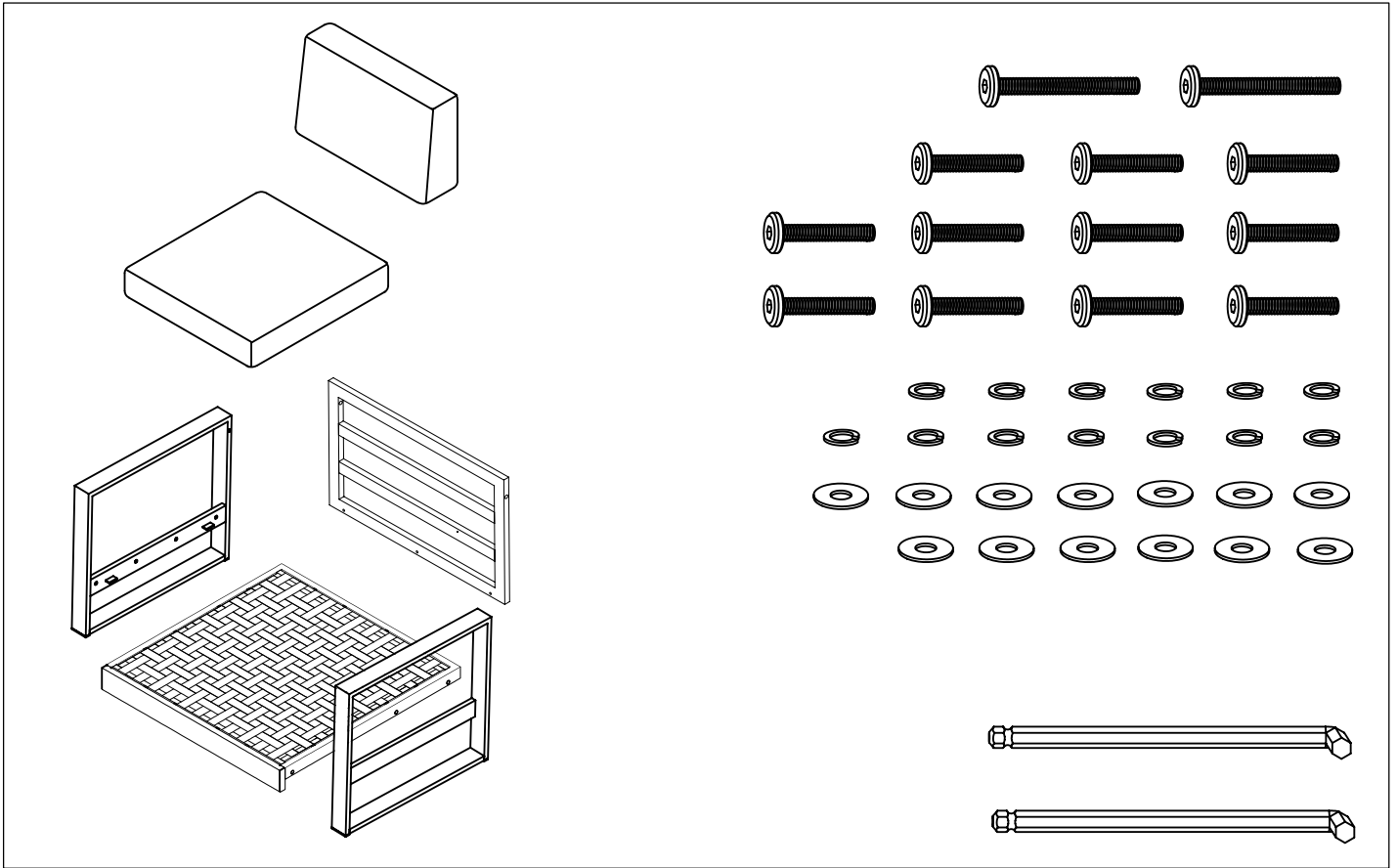

Unpack all hardware bags and components to ensure you have all parts. Take note of bolt hardware size differences and components that may have directional labels (Example: TOP or FRONT).



Read the assembly instructions, cover-to-cover. Save any **Care and Maintenance** instructions pages for after the assembly has been completed.



It is always recommended to have 2 adults on hand for assembly.



Do not assemble on hard, abrasive flooring or carpeted surfaces that can damage or get caught in the components during assembly.

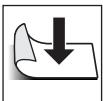

Assemble on a clean non-marring surface (such as the product's packing foam).

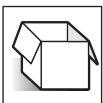

Do not discard any packaging until the product has been fully assembled.







In case of missing parts, please contact your nearest World Market store or call our customer service call center at 1-877-967-5362



WARNING: Small parts are a choking hazard. Adult supervision is required before, during, and after assembly.

Assembly

Step 1

- H-2  Short Allen Bolt (M6x40)mm x3
- H-3  Spring Washer M6 x3
- H-4  Flat Washer (M6x1)mm x3
- T-1  Allen Key x2



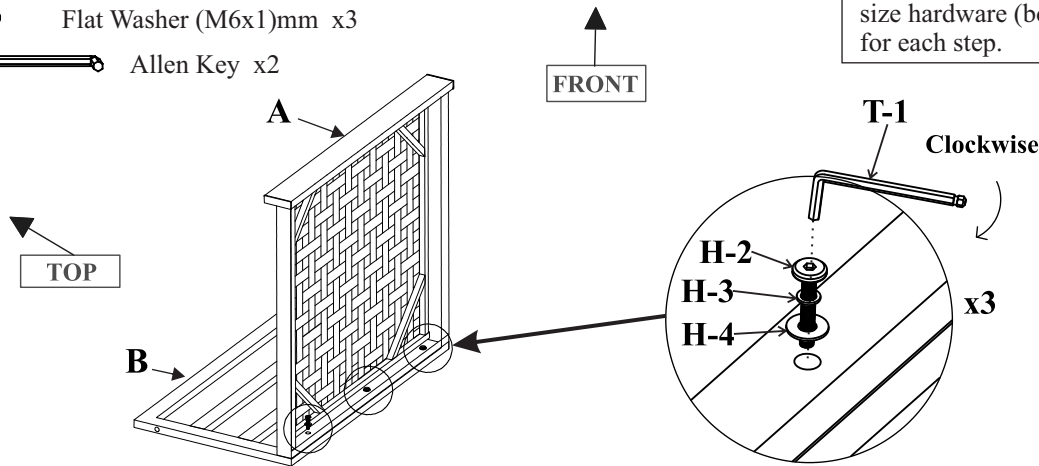

IMPORTANT:

Please make note of the different hardware sizes and ensure you are using the correct size hardware (bolts, screws and washers) for each step.



Using a second person to assist you, position the Seat Frame (A) with the Back Frame (B) as shown. While one person holds the Seat Frame (A), secure with Short Allen Bolts (H-2), Spring Washers (H-3) and Flat Washers (H-4) using the provided Allen Key (T-1), stacking the hardware in the order as shown. Engage all bolts first, then fully tighten. **DO NOT OVER TIGHTEN.**

Step 2

- H-1  Long Allen Bolt (M6x55)mm x2
- H-2  Short Allen Bolt (M6x40)mm x8
- H-3  Spring Washer M6 x10
- H-4  Flat Washer (M6x1)mm x 10
- T-1  Allen Key x2

IMPORTANT:

Please make note of the different hardware sizes and ensure you are using the correct size hardware (bolts, screws and washers) for each step.

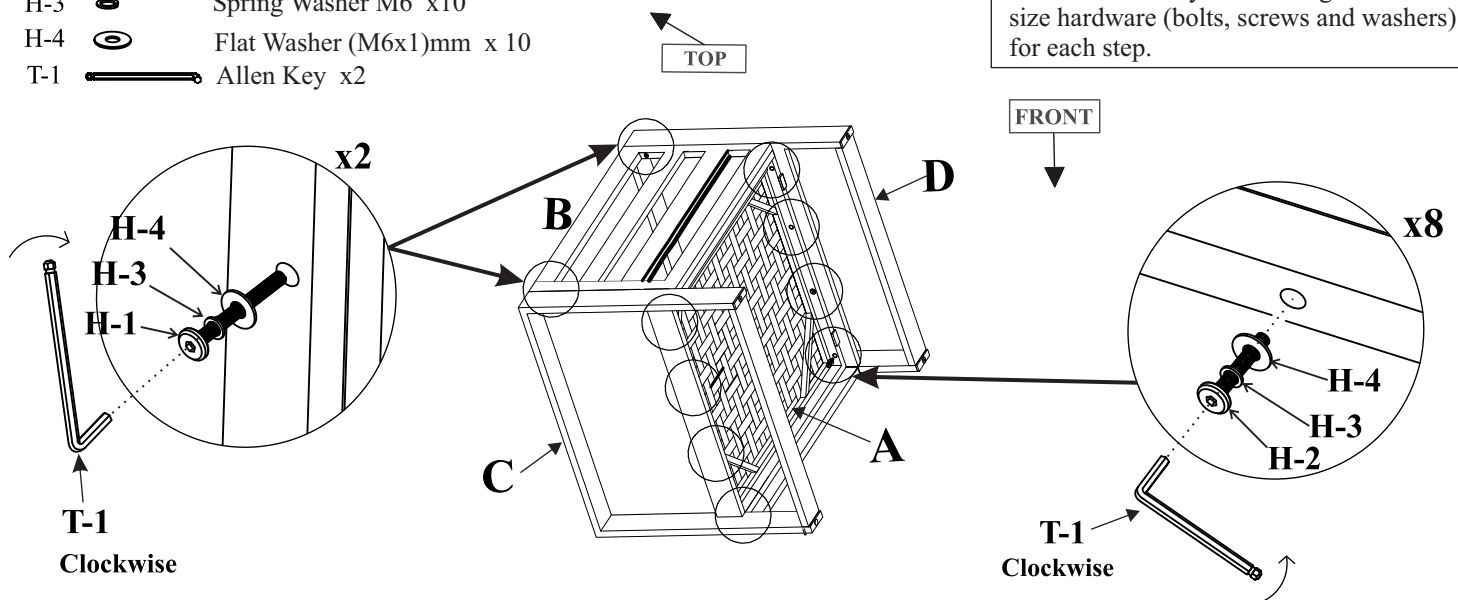

Position the Right Leg (C) with the assembly as shown. Note that the Left/Right Leg (C/D) assemblies have preattached tabs that help align the components. Secure the Right Leg (C) to the **Back Frame (B)** with **Short Allen Bolts (H-2)**, Spring Washers (H-3) and Flat Washers (H-4) using the provided Allen Key (T-1), stacking the hardware in the order as shown. Do not yet fully tighten. Secure the Right Leg (C) to the **Seat Frame (A)** with **Long Allen Bolts (H-1)**, Spring Washers (H-3) and Flat Washers (H-4) using the provided Allen Key (T-1), stacking the hardware in the order as shown. Do not yet fully tighten. Repeat the same process for the Left Leg (D). Once all hardware is engaged, fully tighten. **DO NOT OVER TIGHTEN.**

Assembly

Step 3

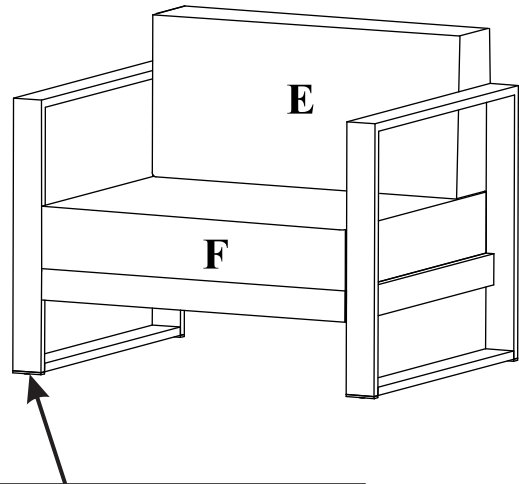
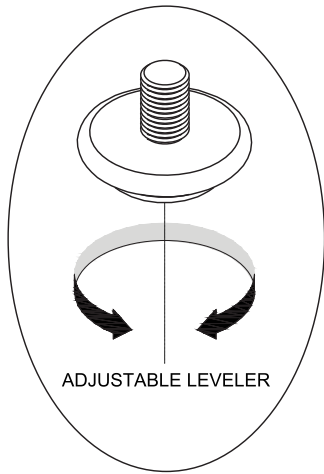

Levelers are located on the bottom of each leg and may be used for additional adjustment if needed for uneven surfaces.

Using a second person to assist you, turn the assembly upright. Place Seat Cushions (G) and Back Cushions (F) into position as shown above. Ensure the zippers face down.

Assembly is now complete and the product is ready for use. Adjustable levelers are located on the bottom of each leg and may be adjusted by turning outwards, counter-clockwise to help account for uneven surfaces.

NOTE: Hardware may loosen over time. Periodically check that all connections remain tight and adjust as needed.

Outdoor Warnings



All products sold at World Market are not for commercial use and are intended for residential use only.



IMPORTANT: ALWAYS store furniture or use appropriate furniture covers during cold or inclement weather or during periods of non-use.

Outdoor Care & Maintenance



DO NOT put hot items directly on furniture surface.



DO NOT clean furniture with harsh cleansers or polish.



DO NOT place furniture near outdoor exhaust vents.



DO NOT write on furniture without a padded barrier to protect the surface.

For Outdoor Products with Upholstery



Dust and pick up spills using a clean, non-colored, lint-free dry cloth.



Treat any spills or stains immediately. **DO NOT** let it soak into the fabric.



Solid and liquid stains can be spot cleaned using a clean white cotton cloth. We also recommend our Outdoor Cushion Cleaner (sold separately). Scan the QR code to the right of this message.

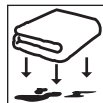

Dab the stain with light, even pressure. **DO NOT** rub the stain when spot cleaning.



For Outdoor Products with Wood

CAUTION: As with any wood, the color may fade when left in direct sunlight or inclement weather. Minor cracking may occur with age. These are naturally occurring features of wood and do not affect product performance.

We recommend using our Outdoor Wood Furniture Finish (sold separately) to help preserve and protect the wood and finish. Scan the QR code above for more information.



SCAN HERE FOR
OUTDOOR FURNITURE FINISH



WORLD MARKET LIMITED ONE-YEAR WARRANTY – Outdoor Furniture

For your customer satisfaction, this product carries a LIMITED ONE-YEAR WARRANTY from the date of delivery. This limited warranty only applies to World Market brand furniture, and not to other furniture brands sold on World Market's website.

Where applicable, the limited warranty provides coverage for:

1. **Manufacturing, Material and Workmanship Defects:** Includes defects related to core frame/structure substrates (wood, metal and stone/tile); complete breakage of hardwood; cracking, splitting or lifting of wood veneer or laminated top surfaces caused by process failure; broken welds or improperly coated metal frame components (powder coating or painted); outdoor fabric, nautical rope and woven Textilene® defects including tears, misprints, fraying, crease marks, skip stitches or open seams; synthetic resin wicker breakage or unraveling; and other component failures that are a direct result of manufacturing or workmanship defects.
2. **Cushions:** Loss of resiliency from a material breakdown of foam or fiber filling, which should not be confused with softening or settling during normal use.
3. **Outdoor Furniture Components (Hardware & Mechanisms):** Includes defects to pre-installed components or hardware provided to the customer for assembly such as metal bases, swivel plate mechanisms; for umbrellas, canopy crank mechanism, spring loaded pole pins (for adjusting height); and other components such as bent or stripped threaded leg posts and adjustable levelers. Coverage also includes protection against rust and corrosion on hardware. For missing, damaged, corroded, or misplaced hardware components such as bolts or washers, please contact Customer Service at: 877-967-5362.

This LIMITED ONE-YEAR WARRANTY does NOT cover:

1. Damage due to mishandling during transportation from store or transportation without original protective packaging.
2. Abuse, negligence (product misuse), improper storage, stacking or wear and tear that may result in or from:
 - a. **Wood & Veneer:** Mishandling, prolonged exposure to moisture, peeling or discoloration caused by exposure to moisture or excessive sunlight, heat; splintered, dented or nicked panels, legs or component edges or paint/finish blemishes; or treatment with corrosive chemicals (dyes, inks, paints or harsh cleaning products). **NOTE: As with any outdoor rated wood, the color may fade if left in direct sunlight of inclement weather. Minor cracking may occur with age. These are naturally occurring features of wood and do not affect product performance.**
 - b. **Fabric (Including Sunbrella® Fabrics), Rope, Textilene®, All-Weather Wicker:** cuts, punctures, tears, burns, pet damage, or treatment with corrosive chemicals (dyes, inks, paints or harsh cleaning products), exposure to fire, high heat, water, or prolonged exposure to direct sunlight that may cause splitting, peeling, fraying or discoloration with time.
 - c. **Foam (Cushions):** Flattening, relaxing or settling/softening of foam components that comes with normal use.
 - d. **Hardware Components:** improper installation or misuse/substitution of hardware components not defined in the Assembly Instructions for the product (if applicable)
3. Damage due to prolonged environmental/inclement weather exposure such as direct sunlight, extreme heat, water or extreme humidity, strong winds, any bright light source (natural or artificial), chlorine or saltwater pools, or any environment that the product is not intended for. We HIGHLY recommend storing furniture, umbrellas and cushions with outdoor rated furniture covers and out of direct exposure during the winter or inclement weather events.
4. This warranty is applicable for outdoor furniture products purchased for residential use only.

For additional information on returns, please visit: <https://www.worldmarket.com/category/customer-service/returns.do>

All products sold at World Market are NOT FOR COMMERCIAL USE and are intended for residential use only. Products purchased for commercial use will VOID all warranty provisions as listed above.

Any claims under this LIMITED ONE-YEAR WARRANTY are valid and applicable only as to the original purchaser and must be accompanied by proof of purchase. Warranty claims should be submitted to a World Market store or through World Market Customer Service Call Center, Toll Free at 877-967-5362.

For valid warranty claims, World Market will repair or replace the product, or offer a full or partial credit, in the sole discretion of World Market. This LIMITED ONE-YEAR WARRANTY gives you specific legal rights and you may also have other rights which vary from state to state.

(OUTDOOR FURNITURE 1LW_v1.4_071423)